



**PREMIUM
FOLDING
TENTS**

Since 1989.

ALL FOLDING TENTS ARE THE SAME?

Set up in no time with just 2 people and no tools. This is one of the few things that Pro-Tent has in common with other folding tents. Only Pro-Tent offers the incredible versatility and proverbial quality that is the hallmark of our folding tents. Our claim is to provide you with a premium product that works perfectly and reliably even after 10 or 15 years of intensive use.

Pro-Tent - discover the difference!



PRO-TENT Germany

PRO-TENT GmbH
Im Brühl 1
65589 Hadamar-Ndz.
Germany
Tel.: +49 (0) 6433 946668-0
info@pro-tent.de

PRO-TENT Switzerland

PRO-TENT AG
Neuhofstrasse 10
8630 Rüti
Schweiz
Tel.: +41 (0) 55 220 28 00
info@pro-tent.ch

pro-tent.com

Let your skills unfold 3

ONLY SATISFIED WITH THE BEST?

We invented the aluminium folding tent in 1989. Since then, we have been working hard to make a brilliant idea just a little bit better. Because only the best is good enough for you.



**Challenge
Smart
vs Pro-Tent**



Video

LOTS OF ADDED VALUE

Other folding tent suppliers offer different tent sizes in 2 or more profile thicknesses. They sell you a tent - and that's it!



In-house production



In-house sewing workshop



In-house print shop

At Pro-Tent, it's different. Of course, we also have different profile thicknesses and tent sizes. But there are also many other ways to customise your tent to suit you and your needs. That's why we put so much emphasis on personal, in-depth advice up front.

The first step is to find out more about you. For what purpose are you looking for a folding tent? How often and where will you use it? Will you be using it for product presentation? Then it's good to know more about your products so that you can show them off to their best advantage with the right accessories.

Your folding tent will only be perfect if the tent configuration, equipment and printing are tailored to you and your requirements.

Then we are happy - because you are happy.



Pro-Tent printing service

Exclusive accessories

3 series, 12 sizes

Cabins

Counter solutions

WHICH PRO-TENT IS THE RIGHT ONE FOR YOU?



PRO-TENT 2000

Lightweight and compact

- Square profile
- Diameter 30 mm



PRO-TENT MODUL 4000

Sturdy and versatile

- Omega profile
- Diameter 40 mm



PRO-TENT 5000

It doesn't get any more stable than this

- Omega profile
- Diameter 45 mm

Three tents that can take on any challenge:
Are you looking for maximum stability? Then our Pro-Tent 5000 series is the one for you. Our Pro-Tent MODUL 4000 series is a handy all-rounder, which will stand up to anything. And the tents in our entry-level Pro-Tent 2000 series offer you the lowest weight and pack size.

- AI** Special aluminium alloy - gives our profiles the characteristic Pro-Tent Shine
- ★** Scratch-resistant, rustproof, durable
- 🕒** 5-year warranty on all tent frames*

* according to the Pro-Tent warranty conditions

THE PRO-TENT ΩMEGA PROFILE

The Omega profile makes all the difference: 16 edges with the characteristic system groove. The principle: Side walls are **inserted directly into the system groove of the poles**, making them wind and rain proof, ...

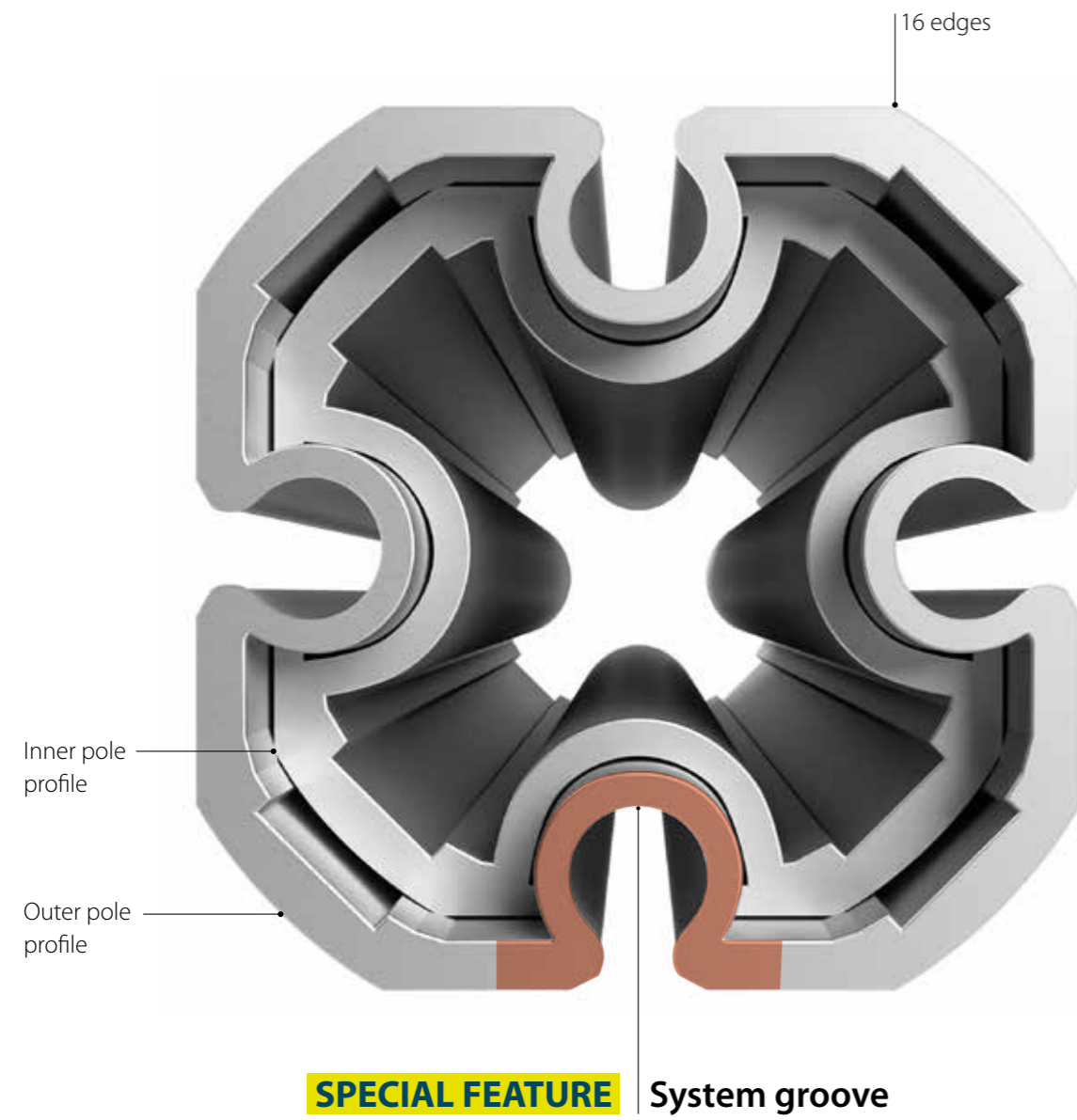

... cross-connectors and other original accessories **are fixed in the groove with quick-release locks**. A Torx key is supplied to open and close the locks. Ingeniously simple, simply ingenious!

Cross-connector fastening

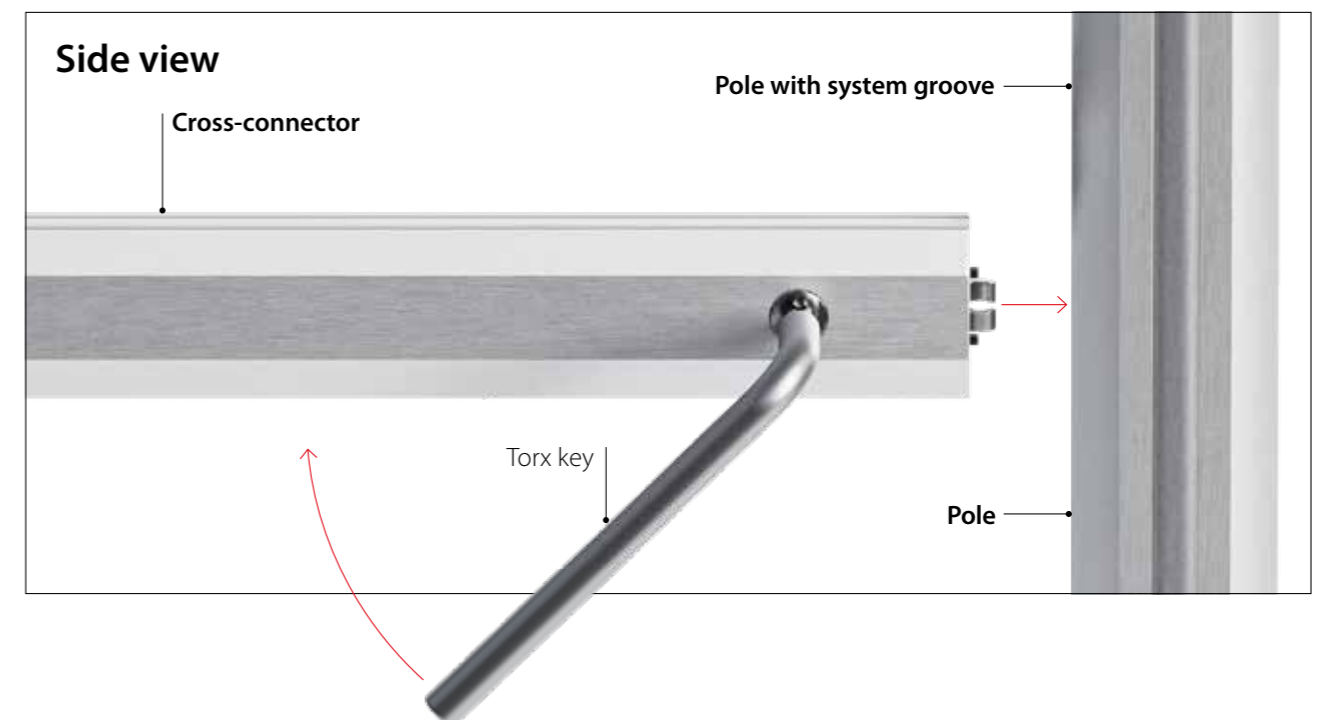
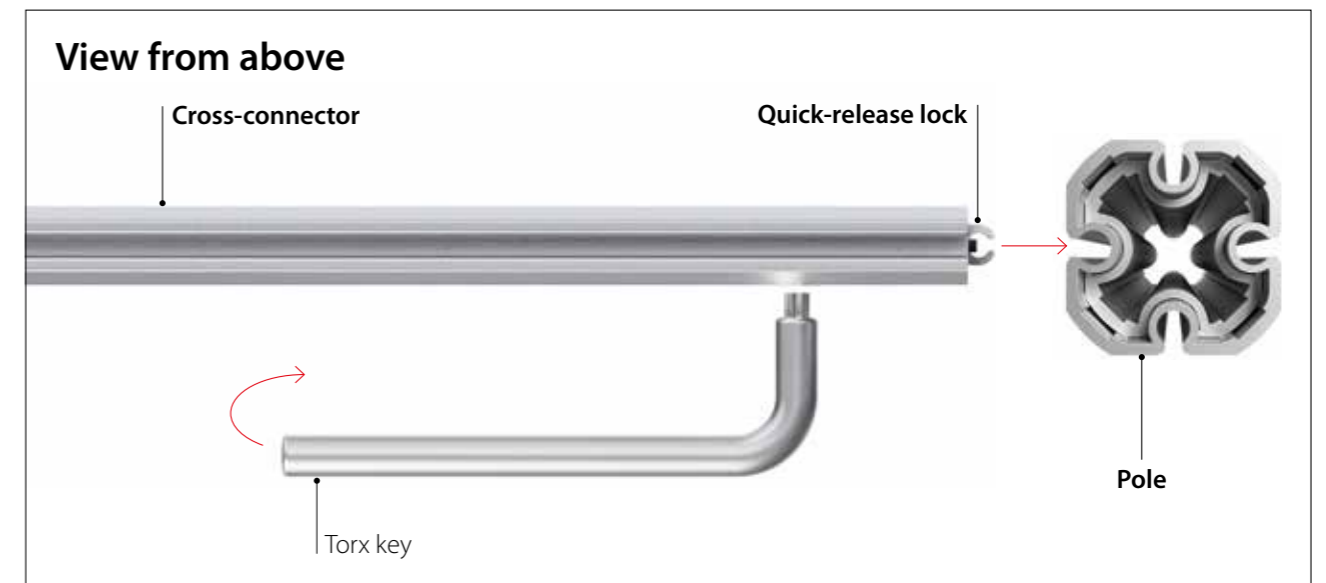

TENT SIZES

Think big?
Find the right tent size on the following pages!

1.5 x 1.5 m



Series	Pro-Tent MODUL 4000
Profile thickness	Ø 40 mm
Height ¹	2 m/2.90 m
Weight ²	19 kg
Pack size	35 x 35 x 156 cm

2 x 2 m



Series	Pro-Tent 2000	Pro-Tent MODUL 4000
Profile thickness	Ø 30 mm	Ø 40 mm
Height ¹	2 m/3.10 m	2 m/3.10 m
Weight ²	18 kg	22 kg
Pack size	29 x 29 x 155 cm	35 x 35 x 156 cm

3 x 3 m



Series	Pro-Tent 2000	Pro-Tent MODUL 4000	Pro-Tent 5000
Profile thickness	Ø 30 mm	Ø 40 mm	Ø 45 mm
Height ¹	2 m/3.30 m	2 m/3.30 m	2 m/3.30 m
Weight ²	25 kg	30 kg	45 kg
Pack size	29 x 29 x 155 cm	35 x 35 x 156 cm	41 x 41 x 156 cm

2.4 x 2.4 m



Series	Pro-Tent 2000
Profile thickness	Ø 30 mm
Height ¹	2 m/3.30 m
Weight ²	21 kg
Pack size	29 x 29 x 155 cm

3 x 1.5 m



Series	Pro-Tent MODUL 4000
Profile thickness	Ø 40 mm
Height ¹	2 m/2.70 m
Weight ²	19 kg
Pack size	35 x 27 x 156 cm

4.5 x 3 m



Series	Pro-Tent 2000	Pro-Tent MODUL 4000	Pro-Tent 5000
Profile thickness	Ø 30 mm	Ø 40 mm	Ø 45 mm
Height ¹	2 m/3.30 m	2 m/3.30 m	2 m/3.30 m
Weight ²	32 kg	40 kg	60 kg
Pack size	39 x 29 x 155 cm	47 x 35 x 156 cm	54 x 41 x 156 cm

3 x 2 m



Series	Pro-Tent 2000	Pro-Tent MODUL 4000
Profile thickness	Ø 30 mm	Ø 40 mm
Height ¹	2 m/3.10 m	2 m/3.10 m
Weight ²	21 kg	29 kg
Pack size	39 x 29 x 155 cm	47 x 35 x 156 cm

4 x 2 m



Series	Pro-Tent 2000	Pro-Tent MODUL 4000
Profile thickness	Ø 30 mm	Ø 40 mm
Height ¹	2 m/3.10 m	2 m/3.10 m
Weight ²	31 kg	39 kg
Pack size	50 x 29 x 155 cm	59 x 35 x 156 cm

6 x 3 m



Series	Pro-Tent 2000	Pro-Tent MODUL 4000	Pro-Tent 5000
Profile thickness	Ø 30 mm	Ø 40 mm	Ø 45 mm
Height ¹	2 m/3.30 m	2 m/3.30 m	2 m/3.30 m
Weight ²	43 kg	50 kg	75 kg
Pack size	50 x 29 x 155 cm	59 x 35 x 156 cm	68 x 41 x 156 cm

THINK BIG!



Our standard sizes are not big enough for you? Show off your true size - up to 8 x 4 metres - with our Pro-Tent 5000 Series. Think big!

4 x 4 m



Series	Pro-Tent 5000
Profile thickness	Ø 45 mm
Height ¹	2.15 m/4.04 m
Weight ²	50 kg
Pack size	41 x 41 x 207 cm

6 x 4 m



Series	Pro-Tent 5000
Profile thickness	Ø 45 mm
Height ¹	2.15 m/4.04 m
Weight ²	66 kg
Pack size	54 x 41 x 207 cm

8 x 4 m



Series	Pro-Tent 5000
Profile thickness	Ø 45 mm
Height ¹	2.15 m/4.04 m
Weight ²	82 kg
Pack size	68 x 41 x 207 cm

14 FABRIC COLOURS

Choose the colour that suits you from our range of standard colours for roofs and side walls. Do you need a custom colour? Then please contact us.



Certified recycled polyester in accordance with the Global Recycled Standard (GRS)



100% waterproof - all seams additionally welded



Water column 10,000 mm



Permanently flame-retardant (B1-classified in accordance with EN 13501-1)



UPF 50+ (98% of UV radiation is blocked)

Printing?
We can produce your print motif in Pro-Tent's own print shop. From logos to photorealistic motifs, everything is possible.

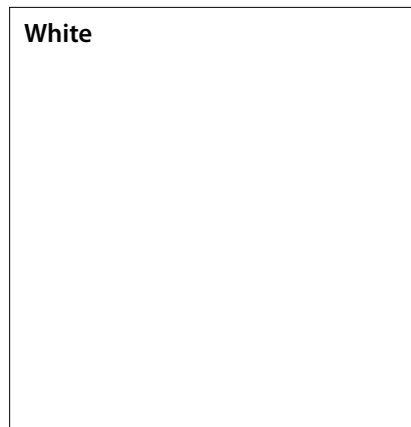

White



Beige
Pantone 4685 C



Sun yellow
Pantone 116 C

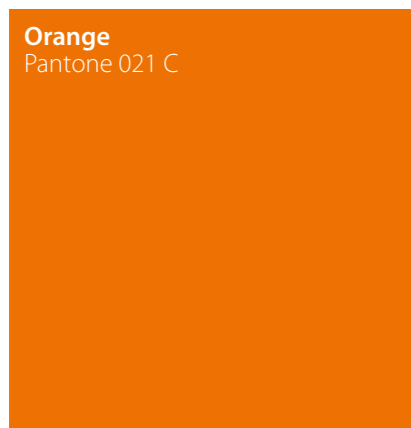

Orange
Pantone 021 C



Swiss red
Pantone 485 C



Ruby red
Pantone 201 C

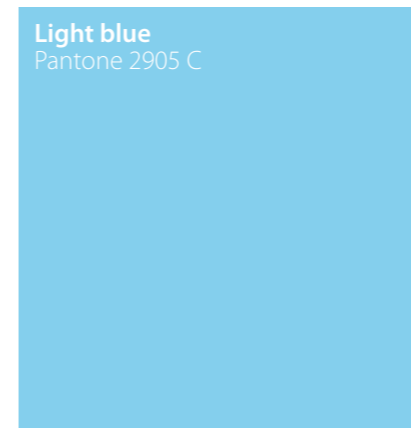

Light blue
Pantone 2905 C



Royal blue
Pantone 2728 C



Marine blue
Pantone 534 C



Grass green
Pantone 368 C

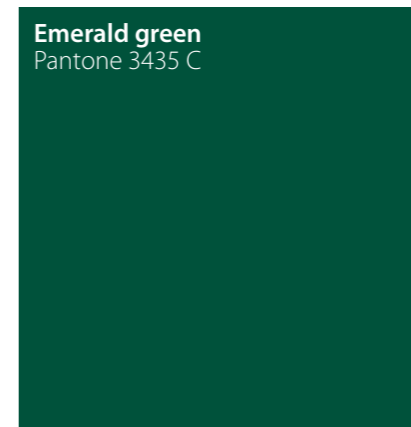

Emerald green
Pantone 3435 C



Silver grey
Pantone 430 C



Anthracite
Pantone Cool Gray 11c

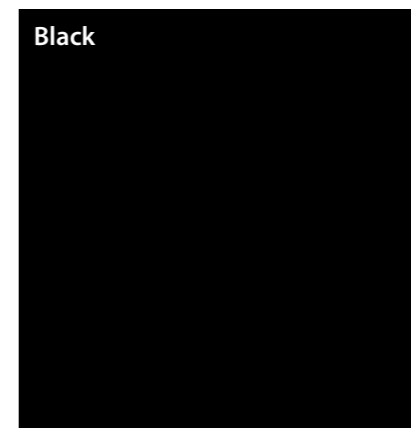

Black

We will be happy to send you original colour samples of our fabrics. Simply use the contact form on our website.

Pantone specifications are for guidance only. Other colours available on request.

Deviations from the original colours are possible and unfortunately unavoidable due to the printing process.

WELL THOUGHT, WELL DONE

The special quality of our folding tents becomes apparent when you take a look at the well thought-out construction details.



SPECIAL FEATURE Gable compression spring

A technical masterpiece: The dynamic resistance ensures a perfectly tensioned tent roof and reduces the load placed on the folding frame by sudden gusts of wind.



Push button release

for easily and safely unlocking the folding construction when dismantling the folding tent.

Corner connectors and joints made of high-tech plastic

are precisely designed to match the load-bearing characteristics of the aluminium profiles.



Panel tensioners

provide extra tensioning to the tent roof and give the roof a great look

Reinforcements in the roof

protect against wear and tear.



Optimised profile cross-sections

based on FEM analyses (finite element method for calculating maximum strength and rigidity).

HOW YOUR PRO-TENT IS DELIVERED

The Pro-Tent MODUL 4000 and Pro-Tent 5000 series are delivered in a padded, mobile transport bag with large, sturdy wheels so that you can easily pull the bag to the site like a golf bag. Folding tents from the Pro-Tent 2000 series are supplied in robust standard transport bags.

After initial assembly, the roof of our folding tents can remain on the frame and be stowed away completely in the transport bags. The next time you need to set up your tent it will be even quicker.

Delivery includes	Pro-Tent 2000	Pro-Tent MODUL 4000	Pro-Tent 5000
Standard transport bag	●	–	–
Padded, mobile transport bag	optionally available	●	●
Tensioning set (pegs 30 cm/tensioning ropes)	●	●	–
Professional tensioning set (pegs 50 cm/tensioning ropes with quick releases/rubber hammer)	–	–	●
Torx key (for opening and closing the quick-release locks)	–	●	●
Adapter strip pliers (for disassembling the side walls)	–	●	●

Premium folding tents come with a premium transport concept. The Pro-Tent mobile transport bag is included free of charge with the Pro-Tent MODUL 4000 and Pro-Tent 5000 series.



Pro-Tent is a Swiss quality product. All tents undergo a comprehensive quality and function test before delivery. However, should you have any reason to complain, we will replace any faulty parts free of charge as part of the 5 year warranty on our frames, in accordance with the terms of the warranty.

TOTAL FLEXIBILITY

SPECIAL FEATURE Additional poles

A special feature of the Pro-Tent MODUL 4000 and Pro-Tent 5000 series is the modular system based on a 1.5 m or 2 m grid. This allows additional poles to be added to the folding structure in a few simple steps. Combined with side walls and cross-connectors, individual room dividers, cabins/cubicles and/or flexible counter solutions can be created.

With our online configurator, you can create the configuration you want in just a few clicks.



Motif/inside wall

Example for a 4.5 x 3 m tent

- standard pole
- additional pole

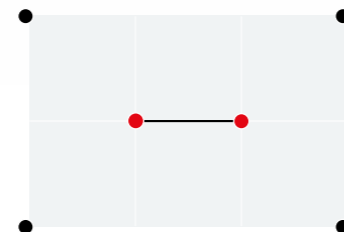

Bar counter offset inwards

Example for a 4.5 x 3 m tent

- standard pole
- additional pole

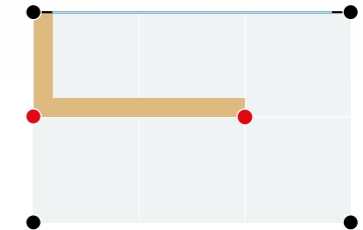

Cabins

Example for a 4.5 x 3 m tent

- standard pole
- additional pole

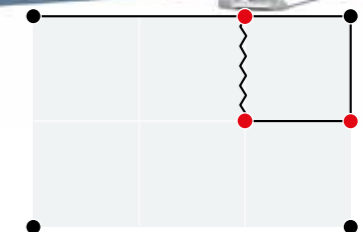

GET INSPIRED!



Example for a 6 x 3 m tent
with cabin 3 x 1.5 m

- standard pole
- additional pole

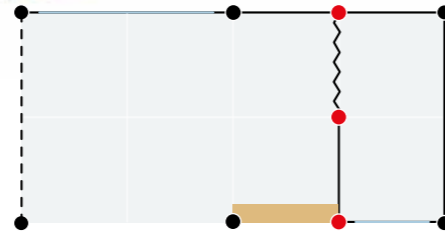

Example of a 4 x 4 m tent
with 2 bar counters of 2 m each and 2 m partition wall

- standard pole
- additional pole

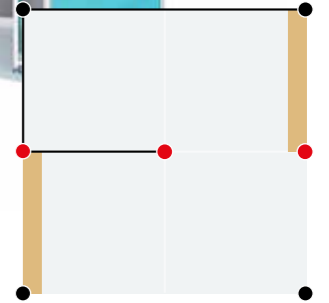

Example of a 4.5 x 3 m tent
with promotion cabin 1.5 x 1.5 m

- standard pole
- additional pole

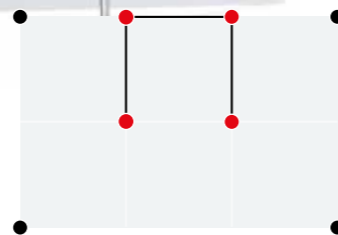

Example of a 4.5 x 3 m tent
with inwardly offset bar counter

- standard pole
- additional pole

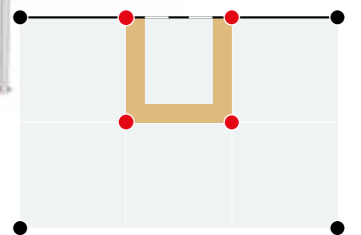



Example for a 6 x 3 m tent
with cabin 3 x 1.5 m and 3 x 1.5 m inwardly offset bar counter

- standard pole
- additional pole

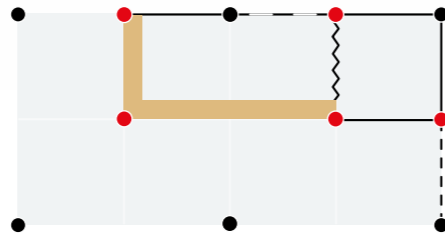

Example of a 4 x 4 m tent
with side wall 2 m and bar counter 2 m

- standard pole
- additional pole

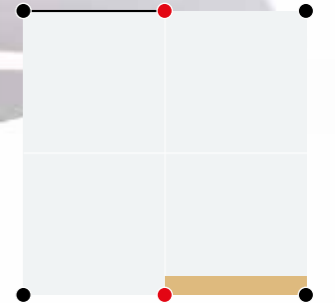

Example for a 4.5 x 3 m tent
with half-height side walls 3 m or 1.5 m

- standard pole
- additional pole

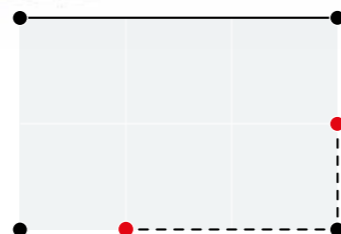

Example for a 4.5 x 3 m tent
with partition walls

- standard pole
- additional pole

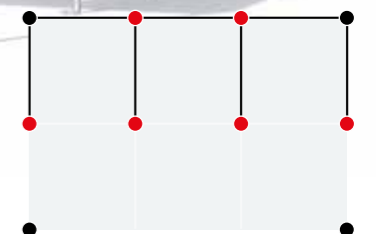

FROM FOLDING TENT TO OUTDOOR EXHIBITION STAND



WITH THE ORIGINAL
ACCESSORIES

SIDE WALLS: VELCRO OR PIPING?

Pro-Tent offers side walls in two versions: classic with Velcro fasteners or Pro-Tent exclusive with a piped seam that is pulled into the system groove of the Omega profile. A zip* in the side walls makes it easier for you to insert the piping and the side walls are then completely windproof providing full privacy.

Version with Velcro fasteners

Available for
Pro-Tent 2000
Pro-Tent MODUL 4000
Pro-Tent 5000



SPECIAL FEATURE Version with piping

Available for
Pro-Tent MODUL 4000
Pro-Tent 5000



Assembly video for side walls with piping

*not suitable for opening the side panels.

SIDE WALL VERSIONS

You will also find the perfect match for your specific application in our side panel designs. Available in all the standard Pro-Tent colours or with your own custom print that says who you are and what you do.



1. Half-height*
2. Half-height with bar counter and second side wall to close off (with full-length zip)
3. Panorama
4. Standard
5. Curtain divided in the middle with zip**
6. Standard with door
7. Special walls with extra-long PVC skirts and combined door/window openings (window openings with PVC window, fly screen and privacy screen)



**Custom solutions?
No problem!**



Certified recycled polyester in accordance with the Global Recycled Standard (GRS)



100% waterproof - all seams additionally welded



Water column 10,000 mm



Permanently flame-retardant (B1-classified in accordance with EN 13501-1)



UPF 50+ (98% of UV radiation is blocked)

* You will need a cross-connector of the appropriate size for attachment respectively.

** You need a curtain rail for this version.

CABINS

Additional poles, cross-connectors and side walls - that's all you need to add a cabin to your folding tent at any time and if required, for use as a changing room or storage room, for example.

Within the specified 1.5m or 2m grid, you can freely configure the size and layout of the cabin to suit your requirements.

This option is exclusively available for our Pro-Tent MODUL 4000 and Pro-Tent 5000 series.



Example for a 3 x 3 m tent with cabin 1.5 x 1.5 m

- standard pole
- additional pole

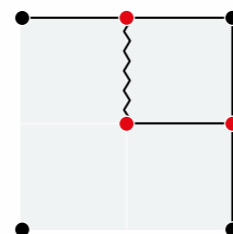

Design your individual Pro-Tent using our **Online configurator**

Example for a 4.5 x 3 m tent with cabin 1.5 x 3 m

- standard pole
- additional pole

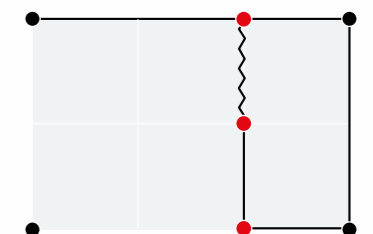

ORIGINAL ACCESSORIES



Example for a 4 x 4 m tent with cabin/room divider 4 x 2 m

- standard pole
- additional pole



Example for a 4.5 x 3 m tent with central cabin 1.5 x 1.5 m

- standard pole
- additional pole



Example of a 3 x 3 m tent with cabin 1.5 m x 1.5m and bar counter 1.5 m

- standard pole
- additional pole



Example of a 6 x 3 m tent with double cabin 1.5 m x 1.5 m each and bar counter 3 m

- standard pole
- additional pole

PRO-TENT BAR COUNTER

The Pro-Tent bar counter turns your folding tent into a mobile drinks or sales stand. When assembling the individual counter modules, the poles made of sturdy aluminium square tubes are first locked into the counter top with push-button springs. Then insert the fabric counter top into the piping groove in the counter top, secure the counter into the system groove of the tent poles with knurled screws - done.

Slight unevenness in the floor can be easily levelled with the swivel feet.

TIP: An additional cross-connector as an end strip gives the bar counter the perfect look.

The Pro-Tent bar counter is available in the following sizes:

- Pro-Tent MODUL 4000: 1 / 1.5 / 2 / 3 / 4.5 m
- Pro-Tent 5000: 1.5 / 2 / 3 / 4 / 4.5 m
- Simple, tool-free installation
- Counter top made from oiled Swiss FSC wood
- Aluminium square tube poles with swivel feet
- Half-height side wall as textile counter trim
- Comes in transport bag

Available for
Pro-Tent MODUL 4000
Pro-Tent 5000

SPECIAL FEATURE Available in a range of sizes and with additional poles, the bar counter can be integrated into your tent as required.

Design your individual Pro-Tent using our **Online configurator**



Example of a 3 x 3 m tent with U-shaped bar counter 3 x 1.5 x 1.5 m

- standard pole
- additional pole

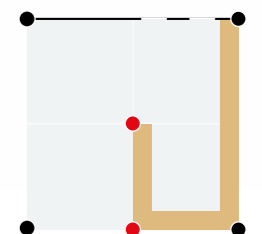

ORIGINAL ACCESSORIES



Example for a 4.5 x 3 m tent with offset bar counter elements (total 9 m)

- standard pole
- additional pole

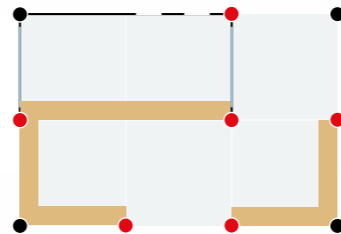

Example of a 4 x 4 m tent with inwardly offset bar counter 4 m

- standard pole
- additional pole

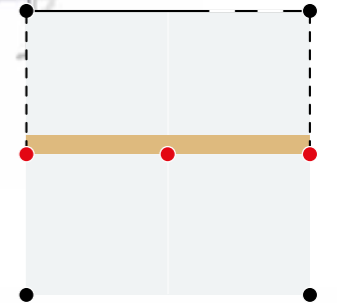

Example for a 6 x 3 m tent with bar counter 3 m (L-shape)

- standard pole
- additional pole

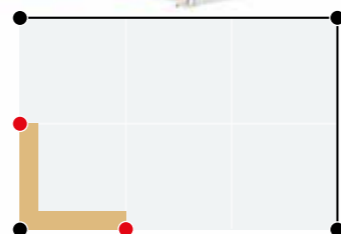

Example of a 6 x 3 m tent with inwardly offset bar counter 3 m

- standard pole
- additional pole

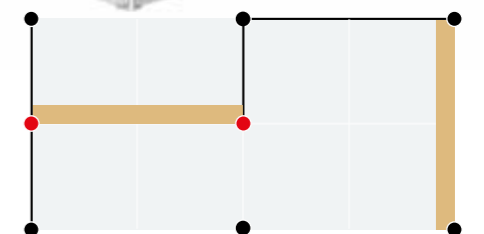



PRO-TENT FLAG SYSTEM

With the exclusive Pro-Tent flag system you can add that extra advertising impact to your event. Visually, the flag and tent frame form a perfect unit, as the flagpole is made from original Omega plug-in profiles.

You will also be impressed with the ease of assembly: The flag system can be assembled in a few simple steps and is attached to the tent pole with two connecting clips.

- Flag fabric made of weatherproof polyester fabric (B1-certified) with high-quality print using the sublimation printing process, with outstanding print resolution and colour saturation, weatherproof and UV-resistant
- With 360° swivel bracket so that the flag is held taut even when there is no wind
- Incl. flag weight (weighs down the flag at the bottom of the pole)
- Comes in a high quality transport bag
- Mass: Flagpole 490 cm (H)/flag 90 x 230 cm (WxH)



Available for
Pro-Tent MODUL 4000
Pro-Tent 5000



Assembly video
flag system



BEACH FLAG ADAPTER

With the Pro-Tent MODUL 4000 and Pro-Tent 5000 series, the beach flag adapter can be fixed at any height in the system groove of the folding tent pole.

Available for
Pro-Tent 2000 (alternative version with brackets)
Pro-Tent MODUL 4000
Pro-Tent 5000



BEACH FLAGS

The classic event flag is available from Pro-Tent in two shapes, each in two sizes:

Drop: 220 cm/330 cm

Straight: 265 cm/360 cm

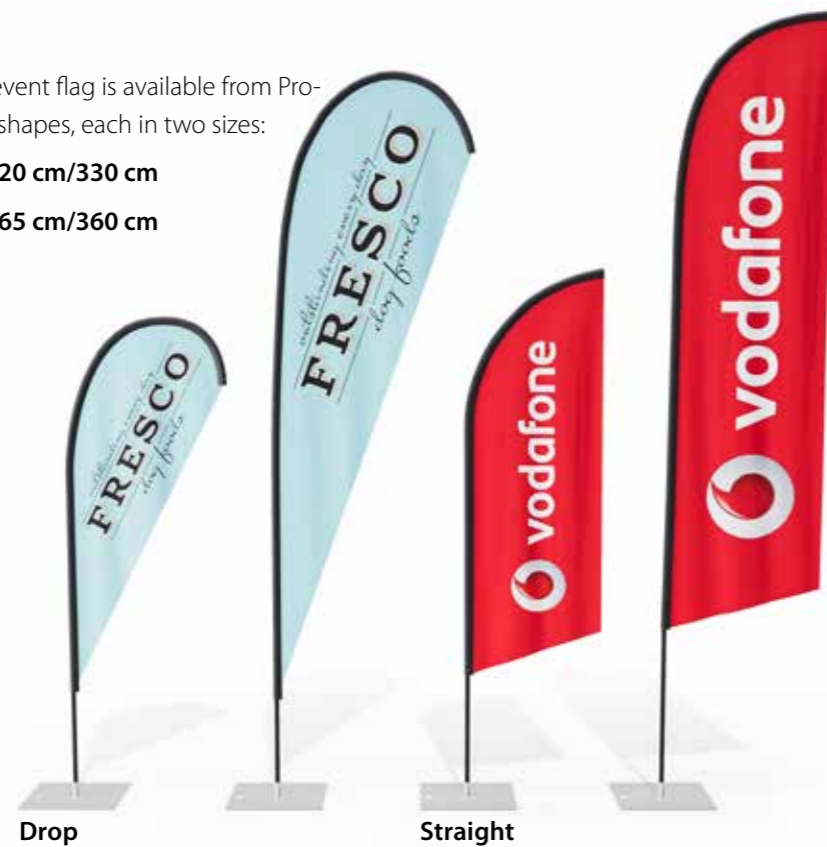

- Beach flag fabric made of weatherproof polyester fabric (B1-certified) with high-quality print using the sublimation printing process, with outstanding print resolution and colour saturation, weatherproof and UV-resistant
- Base plate made of steel, powder-coated/mass: 40 x 40 cm (12 kg)
- Comes in transport bag



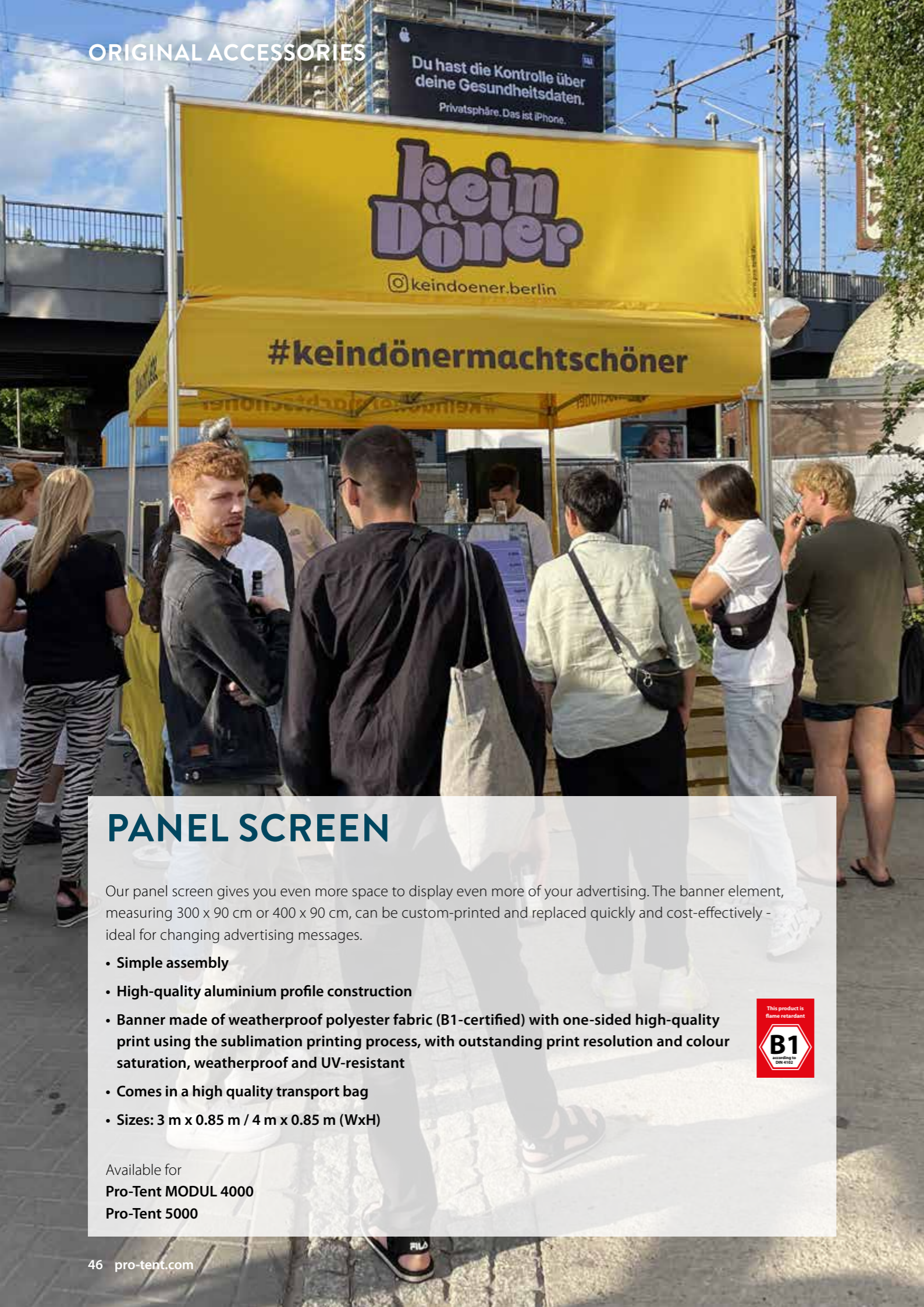

PANEL SCREEN

Our panel screen gives you even more space to display even more of your advertising. The banner element, measuring 300 x 90 cm or 400 x 90 cm, can be custom-printed and replaced quickly and cost-effectively - ideal for changing advertising messages.

- Simple assembly
- High-quality aluminium profile construction
- Banner made of weatherproof polyester fabric (B1-certified) with one-sided high-quality print using the sublimation printing process, with outstanding print resolution and colour saturation, weatherproof and UV-resistant
- Comes in a high quality transport bag
- Sizes: 3 m x 0.85 m / 4 m x 0.85 m (WxH)



Available for
Pro-Tent MODUL 4000
Pro-Tent 5000



CANOPY 80 cm

Our canopy set is a useful addition not only for market tents. With a depth of 80cm, it provides an additional roof and protects your customers and your goods from rain and sun. The canopy is available in all standard Pro-Tent colours to match your tent.

- High-quality aluminium profile construction
- Waterproof, UV-stabilised polyester fabric (B1-certified)
- Comes in a high quality transport bag
- Sizes: 1.5 / 2 / 2.4 / 3 / 4 / 4.5 / 6* / 8 m x 0.8 m (WxD)
 *for tent size 6 x 3 m



Available for
Pro-Tent 2000 (alternative version)
Pro-Tent MODUL 4000
Pro-Tent 5000



As a general rule, we recommend using weight plates to weigh down tents, even if they are tensioned.

PRO-TENT WEIGHT PLATES

To secure your folding tent, use the tensioning set supplied and/or (if the ground conditions do not permit the use of pegs) our original Pro-Tent weight plates or the Pro-Tent water weights.



Weight plate approx. 10 kg alternatively 15 kg

- 10 kg version supplied in a high-quality transport bag



- for a maximum of 4 tents set up next to each other
- Ø 25 cm (10 kg)/Ø 30 cm (15 kg)
- attached to the tent pole with fixing bolts (included in the scope of delivery)



Weight plate 15 kg

- second weight plate can be attached (corresponds to 30 kg per pole)
- 24 x 35 cm (WxL)

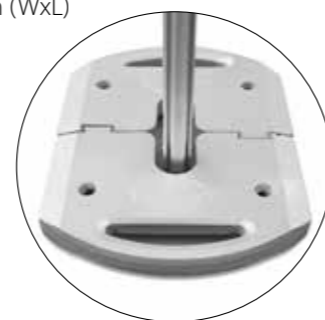

Hexagonal weight plate 12.5 kg

- stackable up to 6 layers (corresponds to 75 kg per pole)
- is located inside the folding tent
- attached to the tent pole with fixing bolts (included)
- 21 x 35 cm (WxL)





WATER WEIGHT

- if it is not possible use pegs or you want to secure your folding tent with additional weight (approx. 50kg)
- with two carrying handles, inlet screw (3 s) at the top and drain plug at the bottom
- attached to the tent with the included tensioning set
- matching quick-tensioning set optionally available for even easier handling
- Ø 45 cm, H 40 cm



SAND WEIGHT

- if it is not possible use pegs or you want to secure your folding tent with additional weight (approx. 18 kg)
- for weighting folding tent poles (only in combination with Velcro side walls)
- Ø 34 cm, H 38 cm



LED FLOODLIGHTS 50 W

High output and long life are the hallmarks of our LED floodlights. The swivelling mounting bracket makes it easier for you to optimally illuminate your folding tent. It is attached to the tent with a sturdy Velcro fastener.



- simple and quick to install
- 5 m-long connection cable
- 6000 K daylight white
- IP 65 (dustproof, hose-proofed, waterproofed)
- transport case optionally available



Available for
Pro-Tent 2000
Pro-Tent MODUL 4000
Pro-Tent 5000

INFRARED RADIANT HEATER

For cold days we recommend: the infrared radiant heater. Installed on the tent in a few simple steps, it provides cosy warmth in your Pro-Tent folding tent in cold weather. It is attached to the tent with a sturdy Velcro fastener.



- simple and quick to install
- quiet and odourless operation
- available in two versions:
IP 44 (splash-proof) / IP 67 (waterproof)
- modern design, high quality branded product

Available for
Pro-Tent 2000
Pro-Tent MODUL 4000
Pro-Tent 5000



Find
these and other
accessories online



PRO-TENT 5000 RESCUE

Rescue tent, mobile operations centre, ambulance or supply station:
Our Pro-Tent 5000 Rescue is the professional solution for all rescue and emergency
services - fully equipped to withstand the rigours of everyday use.

The professional solution for

- Fire-fighting services
- Rescue and medical services
- Technical relief organisations
- Police forces
- Military



PRO-TENT 5000 RESCUE COMPLETE PACKAGE



The Pro-Tent 5000 Rescue is based on the Pro-Tent 5000 tent series - our most stable folding tent series with a profile diameter of 45 mm. In addition to special side walls, the equipment includes a customised, waterproof floor system and weight plates. Everything is supplied in sturdy transport bags.



100% waterproof - all seams additionally welded



Special walls with extra-long PVC aprons



Permanently flame-retardant (B1-classified according to EN 13501-1)



UPF 50+ (98% of UV radiation is blocked)



Waterproof floor system

The Pro-Tent 5000 Rescue is available in the following sizes:

3 x 3 m

4.5 x 3 m

6 x 3 m

4 x 4 m

6 x 4 m

8 x 4 m

Equipment:

- Pro-Tent 5000 tent frame incl. professional tensioning set and tent roof
- 4 special walls with extra-long PVC skirts and combined door/window openings (110 cm wide) with PVC window/ fly screen and privacy screen
- non-slip and tear-resistant PVC floor system with base support for 12.5 kg weight plate including aluminium tubes for connecting the special walls
- 12.5 kg weight plates (one weight plate per pole)
- supplied in sturdy transport bags (mobile tent frame transport bag)

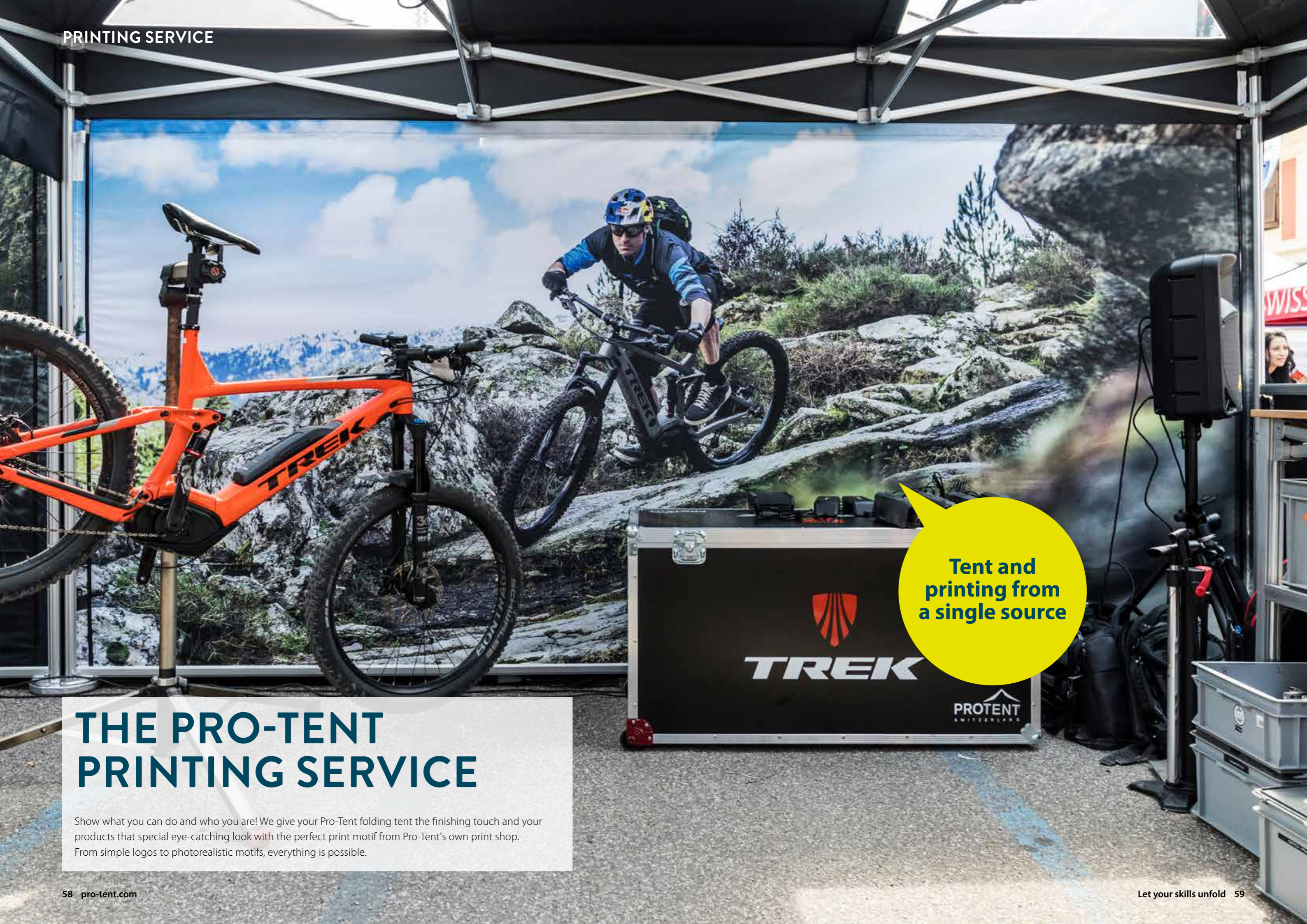

Tent and printing from a single source

THE PRO-TENT PRINTING SERVICE



Show what you can do and who you are! We give your Pro-Tent folding tent the finishing touch and your products that special eye-catching look with the perfect print motif from Pro-Tent's own print shop. From simple logos to photorealistic motifs, everything is possible.

WHAT'S YOUR MESSAGE?



What's your message? We give your folding tents, flags and beach flags the right look with high quality outdoor prints in brilliant colour.

If you wish, our graphics team can take care of the professional design for you. Alternatively, we can provide you or your agency partner with the appropriate design templates and technical print specifications.

-  Pro-Tent's own print shop
-  State-of-the-art printing technology with brilliant colour reproduction
-  Graphics and layout service available on request



We can also provide photorealistic 3D renderings at the quotation stage

CRAFTSMANSHIP AT ITS BEST

Handmade in the best sense of the word is what Pro-Tent stands for. As one of the few suppliers with our own manufacturing, sewing and printing facilities, we are fully focussed on sustainable production. Social commitment is important to us, which is why the BSZ Foundation is also part of the large Pro-Tent family.

People with disabilities have been assembling our folding tents here for many years. Manufacturing a premium product that is appreciated worldwide fills the BSZ employees with particular pride. In the ISO-9001 certified company, individual teams are responsible for different production steps. For example, one team cuts and rounds aluminium profiles, while another drills, mills and cuts the profiles. One group is responsible for oiling and assembling the folding frame, another for functional checks and packaging. After each operation, the workpiece is checked twice by team members and the group leader.



THERE IS NO PLANET B!

Out of personal conviction and in the firm belief that the quality and durability of our products are the key to true sustainability, we want to do our part to ensure that the world we live in remains a world worth living in for future generations.

As a company, we are aware of our economic, ecological and social responsibility and act accordingly. This requires clear principles, long-term goals and a wide range of measures in all areas of the business, which we have set out in our Sustainability Report. We benchmark our results every two years and document our progress. We publish regular progress reports on our website. If you are interested, you can read more about our sustainability strategy here.

Our sustainability principles



Quality

For us, quality and sustainability go hand in hand. After all, the longer the life of a product, the fewer resources are consumed. This requires well thought-out design, the use of high-quality and hard-wearing materials and excellent workmanship.



Continuity

Our aspiration to offer high-quality products and act in an ecologically and socially responsible manner is something we have maintained ever since our beginnings. We are not guided by short-term trends but by our own convictions and the needs of our customers.



Partnership

Our primary goal is not selling per se, but building solid, mutually beneficial partnerships. This also includes cooperation with our suppliers. Long-term business relationships make us a reliable partner for you.



Responsibility

As a company, we bear responsibility and are very aware of this: for the people we work with; for the relationships with our customers, suppliers and business partners; for sound collaboration and the common good at our locations; for the environment in which we live.



Find out
how we think in
our video:





LET'S GET STARTED

We are looking forward to hearing from you and to receiving your enquiry.



SNAP SHOTS

SNAPSHOTS



This is
how to present
a brand! More just
isn't possible ...





Be well-positioned at any event with original accessories and bold prints!



Folding tent
or outdoor
exhibition stand?
Both!





The perfect backdrop for a premium Swiss product!





Whatever you're planning, at Pro-Tent you'll find the tent that suits you and your needs!



We have the solution for what you need. Even if it's 108 square meters!





SNAP SHOTS